Other products available from Apollo

Smart Move® Rotators • Smart Color® Scrollers

Smart Power™ PSU's • Stainless Steel Gobos

• *Gel Miser • MXR Color Mixing Scroller*

• *Right Arm® Glass Gobos*

• *Gel Filters • Dichroics • Tape*

Pattern Holders • Donuts • And Much More!



OPERATING MANUAL

SMART MOVE® VERTICAL

SMART MOVE® VERTICAL DMX



Apollo Design Technology

4130 Fourier Drive Fort Wayne, IN 46818 USA

Phone: +01.260.497.9191 Fax: +01.260.497.9192

www.apollodesign.net



Congratulations on your purchase of the Apollo Smart Move® Vertical.

The SMART MOVE® VERTICAL is the latest addition to the Smart Move® family of gobo effects devices from Apollo Design. The Vertical inherits the same smart technology found in its rotating siblings.

The Vertical features motion, time, and speed presets that create vertical movement of patterns or text. The special gobo offers multiple image areas that, when combined with the vertical movement, allows one image at a time to be placed in the focal path of the fixture.

The Smart Move® Vertical accepts metal, b/w, and one color glass gobos to produce new and exciting projection possibilities. For retail, tradeshow displays, and corporate event environments, text messages and logos can be projected. In a theatrical application many natural movements not suited to rotational effects can now be produced. Just use your imagination!

The Smart Move® Vertical comes in a DMX or standard version. Both have 17 pre-programmed effects for stand alone operation. Fits ETC Source Four and Altman Shakespeare.



Maintenance Kits

Smart Move® Vertical and Smart Move® Vertical DMX kits contain the following replacement parts:

- 12" Bearing tape
- Teflon bushing
- 2 Teflon spacers

Smart Move® Warranty

- Smart Move® Verticals are covered by a 12-month parts and labor warranty. The warranty covers parts and labor for 12 months and freight for 30 days after initial purchase. In case of warranty claims, please contact Apollo Design Technology, Inc. directly at 4130 Fourier Drive, Fort Wayne, IN 46818.
- Products being returned for warranty repair must display the original serial number sticker. Removal of the serial number sticker voids the product's limited warranty.
- Despite the care taken in the compilation of this manual, Apollo Design Technology, Inc. cannot be held may appear in this manual. All efforts have been instructions and illustrations as possible.
- Need assistance? Call Apollo at 800-288-4626.

Keep this information handy if requiring technical assistance.

Serial Number: _____

Date Purchased: _____

Smart Move Vertical Troubleshooting

SMART MOVE® VERTICAL

- **Unit does not move gobo.**
 - Check 110 volt outlet by plugging in a known working lighting fixture.
 - If fixture operates, plug Smart Move power supply in and check for 24 volts DC between the tip and ring of the ¼" power plug.
 - If 24 volts is present, check to see if the address switches are set to 01 through 17. Address 00 is not a valid setting.
 - Smart Moves set at the slowest speed may appear to be not working. Rotate speed knob to highest setting.
 - If the motor is running but there is no vertical movement check the set screw on the drive arm. If loose, tighten.
- **Unit is noisy.**
 - It is normal for a Smart Move Vertical to produce minimal noise when brand new. After heating up once in a lit fixture, the Teflon components "set". All units operate quietly after this initial heat cycle.
 - Smart Move Verticals have been designed and tested for long periods of normal operation. In some extreme cases, the Teflon bushing will wear. Teflon bushings and spacer strips are available in the Smart Move Vertical maintenance kit.

SMART MOVE® VERTICAL DMX

- **Unit does not move gobo.**
 - Check 24 volt DC power source. If any other Smart Move DMX or Smart Color DMX products are available, plug them into the power supply to confirm 24 volts DC. If no other units are available check for 24 volts DC between pin 2 and pin 3 on the 4 pin XLR cable.
 - If 24 volts is present, check to see if the address switches are set to 001 through 512. Address 000 is not a valid setting.
 - Smart Moves set at the slowest speed may appear to be not working. Rotate speed knob to highest setting.
 - Set address switches to "701". This setting will operate the Vertical in stand alone mode in effect 01.
 - If unit operates in stand alone mode but not in DMX control mode verify that the unit is not in the indexing or effects mode. The Smart Move Vertical DMX requires three DMX channels. Make sure that the second and third channels are receiving 0% output.
 - If the motor is running but there is no vertical movement check the set screw on the drive arm. If loose, tighten.
- **Unit is noisy.**
 - It is normal for a Smart Move Vertical to produce minimal noise when brand new. After heating up once in a lit fixture, the Teflon components "set". All units operate quietly after this initial heat cycle.
 - Smart Move Vertical have been designed and tested for long periods of normal operation. In some extreme cases, the Teflon bushing will wear. Teflon bushings and spacer strips are available in the Smart Move Vertical maintenance kit.

Six image areas on Vertical gobo.

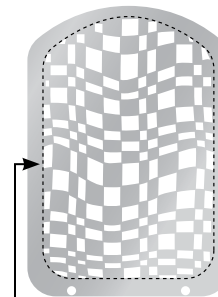

- 1** Use this image area for full size breakups. This image will always be in the light beam. Use an identical or different pattern in the fixture's gobo slot to create additional effects.
Maximum available image area: 4 5/8" (L) x 3" (W)
117.475mm (L) x 76.2mm (W)

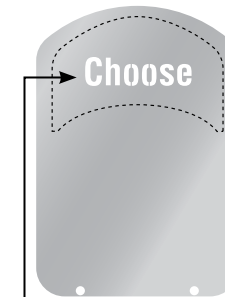

- 2** Images in this area will drop into light beam but not be centered.
Maximum available image area: 1 1/2" (L) x 3" (W)
38.1mm (L) x 76.2mm (W)

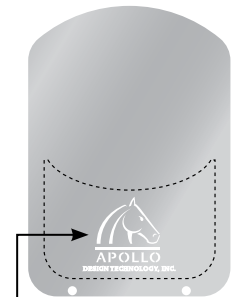

- 3** Images in this area will rise into the light beam but not be centered.
Maximum available image area: 1 1/2" (L) x 3" (W)
38.1mm (L) x 76.2mm (W)

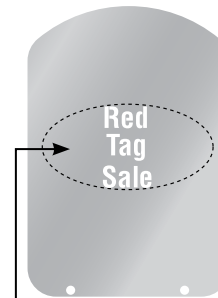

- 4** Use this area for images that will move up and down within the light beam. One, two, or three lines of text can go into this area. One line at a time or all three lines at once can be projected here using the fixture shutters.
Maximum available image area: 1 1/2" (L) x 3" (W)
38.1mm (L) x 76.2mm (W)

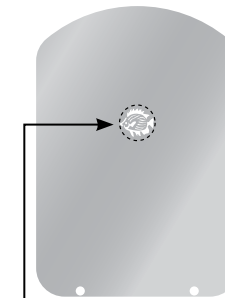

- 5** Use this area for images that will disappear at the top of the light beam. Use in conjunction with area #6 to have one pattern completely replace another pattern in the center of the light beam.
Maximum available image area: 5/8" diameter
15.875mm diameter

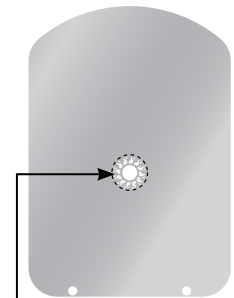

- 6** Use this area for images that will disappear at the bottom of the light beam. Use in conjunction with area #5 to have one pattern completely replace another pattern in the center of the light beam.
Maximum available image area: 5/8" diameter
15.875mm diameter

Close-up of the six image areas on Vertical gobo.

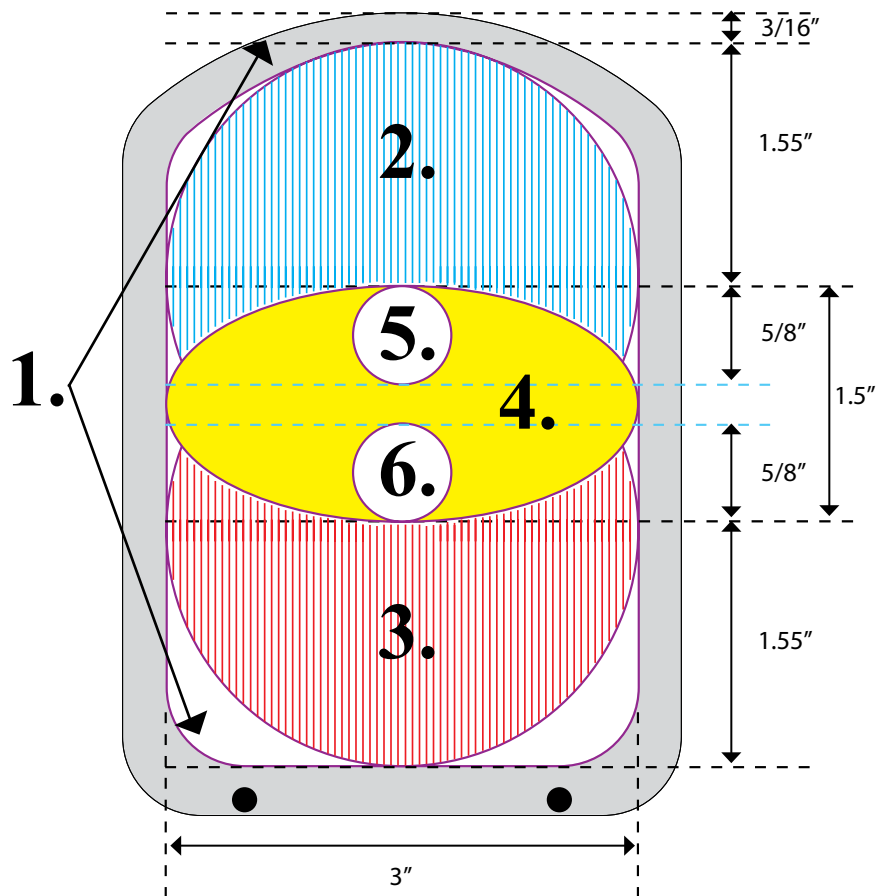

Smart Move® Mode

The Smart Move® Vertical DMX allows the user to access the 17 pre-programmed effects while in DMX mode. In this mode of operation, set:

DMX Channel 3 at 1-100% to enable Smart Mode

DMX Channel 2 at 1-100% to set the speed of the Smart effect

DMX Channel 1 at 1-100% to select the Smart effect

DMX Value	Effect	Description
0-2	00	Stop
3-7	01	Full Range, Continuous
8-12	02	80% Range, Continuous
13-17	03	60% Range, Continuous
18-22	04	40% Range, Continuous
23-27	05	20% Range, Continuous
28-32	06	10% Range, Continuous
33-37	07	1 Second Delay, Top and Bottom
38-42	08	1.5 Second Delay, Top and Bottom
43-47	09	3 Second Delay, Top and Bottom
48-52	10	4.5 Second Delay, Top and Bottom
53-57	11	6 Second Delay, Top and Bottom
58-62	12	7 Second Delay, Top and Bottom
63-67	13	1 Second Delay, Center
68-72	14	3 Second Delay, Center
73-77	15	5 Second Delay, Center
78-82	16	Random Motion, 20% Range
83-100	17	Random Motion, 10% Range

Modes Of Operation

Stand Alone

The Smart Move® Vertical can operate in stand alone mode or can be controlled by a lighting console using DMX 512.

For simple operation without DMX control, set the rotary switches to 701, and then adjust the speed by turning the black speed control knob clockwise for faster movement or counter-clockwise for slower movement. To access the remaining 16 preprogrammed effects, simply set the first rotary switch at 7 and the remaining two rotary switches to correspond to the effects listed on the back of the unit.

DMX Control

The Smart Move® Vertical DMX allows three modes of operation and requires 3 channels of DMX when used with a lighting desk.

Vertical Mode

This mode moves the gobo in a continuous cycle from .25 to 60 strokes per minute. In this mode of operation, set:

DMX channel 3 at 0

DMX channel 2 at 0

DMX channel 1 at 1-100% to set speed

Indexing Mode

This mode allows the user to position the gobo at any of the 200 positions in the stroke. In this mode of operation, set:

DMX Channel 3 at 0

DMX Channel 2 at 1-100% to set speed

DMX Channel 1 at 1-100% to set position

Gobo Installation

The Apollo gobos are held in place with two Phillips head screws for ease of use. Begin installation by sliding the gobo into the slots found at the base of the Smart Move® Vertical. For correct projection of image, install the gobo with image upside down facing the housing as shown above.

Continue sliding the gobo into the Smart Move® Vertical until the holes in the gobo line up with the screw holes on the gobo carrier plate. Screw two Phillips head screws until tight. Do not Over tighten!

Your Smart Move® Vertical is now ready for use.

Smart Move® Vertical Operation

The Smart Move® Vertical and Smart Move® Vertical DMX fit in the iris slot of the Altman Shakespeare and ETC Source Four Ellipsoidal lighting fixtures. Both units come with a load rated safety ring in the upper corner. It is recommended that an industry approved safety cable be attached to this ring and to a fixed object nearby such as a truss, house pipe or catwalk. This is particularly important when operating the Smart Move® Vertical or Smart Move® Vertical DMX in any orientation other than vertical.

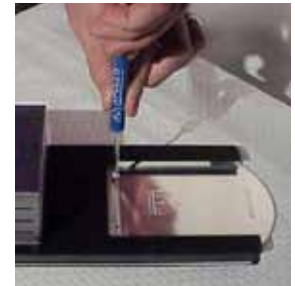

Smart Move® Vertical Operation (Standard Version)

The Smart Move® Vertical is powered by a 24V DC adapter supplied with the unit. It can be plugged into any 120 volt outlet for smooth operation. The 600mA power adapter is a rugged, black plastic molded unit with a ¼ inch heavy duty audio-style jack for long life. Route the power supply cable in such a way as to avoid contact with the lighting fixture.



Do not plug the Smart Move® Vertical into a dimmable source.

The speed of the Smart Move® Vertical is controlled only by the black speed control knob on the side of the enclosure.

After powering up, the Smart Move® Vertical will perform a homing sequence. After homing is completed, usually in no more than a few seconds, the Vertical is ready to use. Set the two rotary switches on the side of the enclosure to 1 of 17 preprogrammed effects. Adjust the speed of the effect using the black speed control knob on the side of the enclosure.

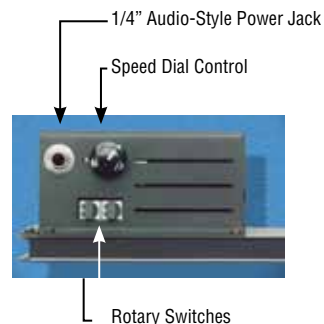

Smart Move® Vertical Operation (DMX Version)

The Smart Move® Vertical is powered by 24V DC. Power, along with DMX data, enter the unit via the two 4 pin XLR connectors located on the top of the enclosure. Route the XLR cables in such a way as to avoid contact with the lighting fixture.

Four sizes of Smart Power™ supplies are available from Apollo.

Smart Power™ 75W will power 5 Smart Move® Verticals
Smart Power™ 200W will power 13 Smart Move® Verticals
Smart Power™ 400W will power 26 Smart Move® Verticals
Smart Power™ 600W will power 40 Smart Move® Verticals

The Smart Move® Vertical is also compatible with the following power supplies:

- Spectra-Q
- Chroma-Q
- Rainbow
- Wybron Forerunner

The Smart Move® Vertical is not compatible with Wybron Coloram power supplies!